

H200

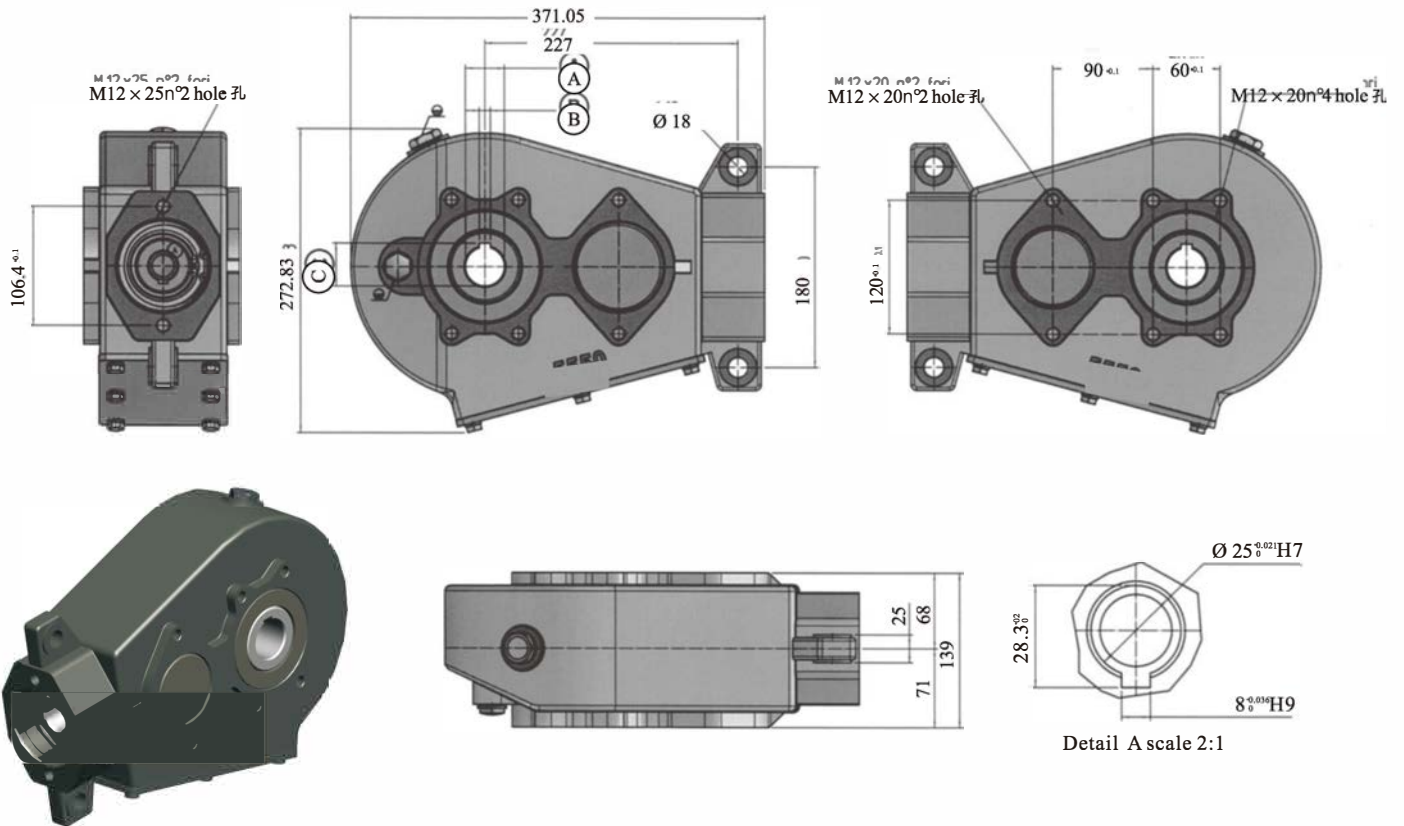

速比 Ratio	输出扭矩 Output torque N · m	重量 Weight Kg	润滑油 Lubrication	工作温度 Work temperature
16.43:1	2000	28	齿轮油 GEAR OIL CE80W90	-20° / +80°

A	B	C
Ø35	10	38,6
Ø40	12	43,3
Ø45	12	48,8